

SECTION A-A

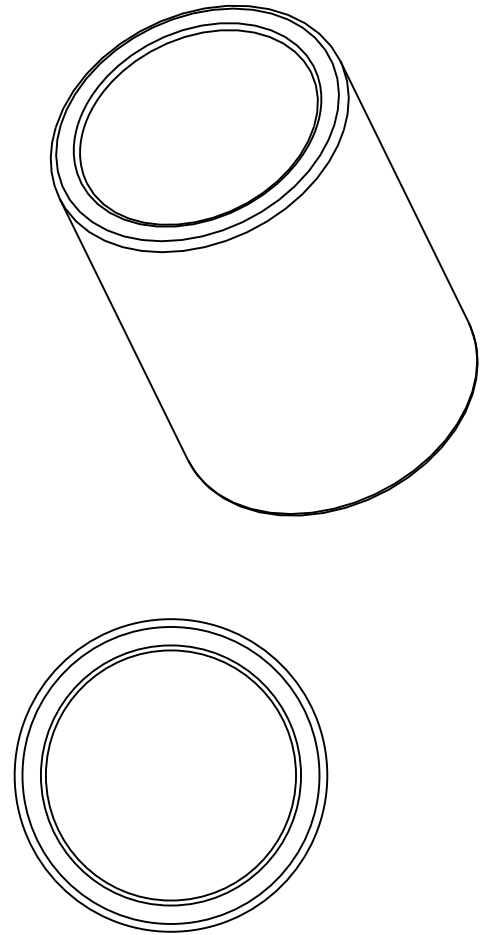

All dimensions in inches

NOTE1: Impregnated with 100 Grade R&O turbine oil unless otherwise specified

NOTE2: Typical PM Chamfers All Corners

MATERIAL:
CT-1000-K26 (SAE 841)
Sintered Bronze

DRAWING NOT TO SCALE

SYMMCO INC.
Bronze Sleeve Bearing
SS-6480-56
2 ID 2-1/2 OD 3-1/2 LEN